



DC – 26.5 GHz SPDT GaAs MMIC Switch

Technical Data

HMMC-2027

Features

- **Outputs Terminated in 50 Ω When Off**
- **Frequency Range:**
DC- 26.5 GHz
- **Insertion Loss:**
2.5dB @ 26.5 GHz
- **Isolation:** >70 dB @ 45 MHz
30 dB @ 26.5 GHz
- **Return Loss:**
15 dB (Both Input and Selected Output)
12 dB Unselected Output
- **Switching Speed:**
<1 ns (10%-90% RF)
- **P_{-1dB}:** 18 dBm @ 10 MHz
27 dBm @ 2 GHz
- **Harmonics (DC Coupled):**
<-45 dBc @ 10 MHz and 5 dBm
<-65 dBc @ 2 GHz and 5 dBm

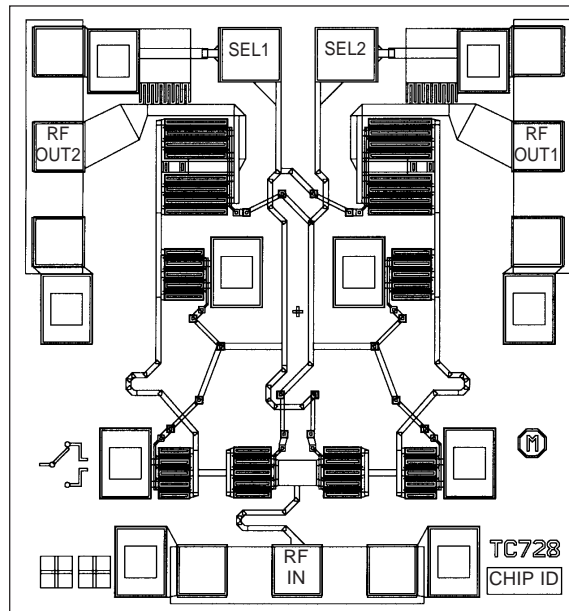

Chip Size: 900 x 960 μm (35.4 x 37.8 mils)
 Chip Size Tolerance: $\pm 10 \mu\text{m}$ (± 0.4 mils)
 Chip Thickness: $127 \pm 15 \mu\text{m}$ (5.0 ± 0.6 mils)
 Pad Dimensions: 80 x 80 μm (3.2 x 3.2 mils), or larger

Description

The HMMC-2027 is a GaAs monolithic microwave integrated circuit (MMIC) designed for low insertion loss and high isolation from DC to 26.5 GHz. It is intended for use as a general-purpose, single-pole, double-throw (SPDT), absorptive switch. Two series and two shunt MESFETs per throw provide 3 dB maximum insertion loss and 30 dB minimum isolation at 26.5 GHz. HMMC-2027 chips use through-substrate vias to provide ground connections to the chip backside and minimize the number of wire bonds required.

Absolute Maximum Ratings^[1]

Symbol	Parameters/Conditions	Units	Min.	Max.
V _{sel}	Select Voltages 1 and 2	V	-10.5	+3
P _{in}	RF Input Power	dBm		25
T _{op}	Operating Temperature	°C	-55	+125
T _{STG}	Storage Temperature	°C	-65	+165
T _{max}	Maximum Assembly Temp.	°C		+200
P _{unsel} ^[2]	Power into Unselected Output	dBm		15

Notes:

1. Operation in excess of any one of these conditions may result in permanent damage to this device. T_A = 25°C except for T_{op}, T_{STG}, and T_{max}.
2. Operation in excess of these @ T_{op-max} may result in permanent damage.

DC Specifications/Physical Properties, $T_A = 25^\circ\text{C}$

Symbol	Parameters and Test Conditions	Units	Min.	Typ.	Max.
I_l	Leakage Current @ -10 V	μA			200
V_p	Pinch-Off Voltage ($V_{\text{SEL}2} = V_p$, $V_{\text{RFout}2} = +2\text{ V}$, $I_{\text{RFout}2} = 2\text{ mA}$, $V_{\text{SEL}1} = -10\text{ V}$, $V_{\text{RFout}1} = \text{open circuit}$, $V_{\text{RFin}} = \text{GND}$)	V	-6.75		-3.00
BV_{gss}	Breakdown Voltage (Test FET w/ $V_D = V_S = \text{GND}$, $I_G = -50\ \mu\text{A}$)	V			-13.0

RF Specifications, $T_A = 25^\circ\text{C}$, $Z_O = 50\ \Omega$, $V_{\text{sel-high}} = 0\text{ V}$, $V_{\text{sel-low}} = -10\text{ V}$

Symbol	Parameters and Test Conditions	Units	Min.	Typ.	Max.
BW	Guaranteed Operating Bandwidth	GHz	DC		26.5
IL	Insertion Loss, RF_{in} to Selected RF_{out} , $f = 26.5\text{ GHz}$, ON throw	dB		2.5	3.0
ISO	Isolation, RF_{in} to Unselected RF_{out} , $f = 26.5\text{ GHz}$, OFF throw	dB	27	30	
ISO	Isolation, RF_{in} to Unselected RF_{out} , $f = 18\text{ GHz}$, OFF throw	dB	40	43	
RL_{in}	Input Return Loss	dB	12	15	
$RL_{\text{out-ON}}$	Output Return Loss, ON throw	dB	13	16	
$RL_{\text{out-OFF}}$	Output Return Loss, OFF throw	dB	9	12	
$P_{1\text{ dB}}$	Input Power where IL increases by 1 dB	$f_{\text{in}} = 2\text{ GHz}$ dBm		27	
t_s	Switching Speed, 10%–90% RF Envelope	$f_{\text{in}} = 2\text{ GHz}$ ns		1	

Applications

The HMMC-2027 can be used in instrumentation, communications, radar, ECM, EW, and many other systems requiring SPDT switching. It can be used for pulse modulation, port isolation, transfer switching, high-speed switching, replacement of mechanical switches, and so on.

Assembly Techniques

Die attach should be done with conductive epoxy. Gold thermosonic bonding is recommended for all bonds. The top and bottom metallization is gold. For more detailed information see Agilent application note #999, "GaAs MMIC Assembly and Handling Guidelines."

GaAs MMICs are ESD sensitive. Proper precautions should be used when handling these devices.

S-Parameters^[1], $T_A = 25^\circ\text{C}$, $Z_0 = 50\ \Omega$, $V_{\text{sel high}} = 0\ \text{V}$, $V_{\text{sel low}} = -10\ \text{V}$

Freq. GHz	S ₁₁			S ₂₁ (Insertion Loss)			S ₃₁ (Isolation)	S ₂₂ (ON Throw)			S ₃₃ (OFF Throw)		
	dB	Mag.	Ang.	dB	Mag.	Ang.	dB	dB	Mag.	Ang.	dB	Mag.	Ang.
0.5	-26.41	0.048	-57.11	-1.08	0.88	-49.06	-67.74	-28.40	0.03	-47.94	-32.26	0.024	47.18
0.5	-18.28	0.12	-7.04	-1.33	0.86	-8.52	-71.40	-18.44	0.12	-9.89	-16.79	0.14	173.87
1.5	-18.53	0.12	-13.70	-1.35	0.86	-14.62	-61.02	-18.46	0.12	-19.75	-16.47	0.15	171.75
4.0	-18.92	0.11	-27.64	-1.41	0.85	-24.53	-51.67	-18.75	0.12	-38.78	-15.36	0.17	168.03
6.5	-19.43	0.11	-45.02	-1.47	0.84	-39.56	-49.50	-19.10	0.11	-63.22	-14.55	0.19	152.55
9.0	-20.57	0.09	-64.07	-1.56	0.84	-55.13	-46.87	-19.72	0.10	15.79	-14.28	0.19	136.68
11.5	-21.85	0.08	-2.59	-1.62	0.83	-71.03	-44.71	-20.91	0.09	243.63	-13.84	0.20	121.81
14.0	-23.10	0.07	258.44	-1.74	0.82	-29.63	-42.30	-22.41	0.08	217.48	-13.53	0.21	106.44
16.5	-24.05	0.06	235.82	-1.88	0.81	258.60	-41.74	-24.17	0.06	179.74	-12.95	0.23	92.94
19.0	-24.59	0.06	224.56	-1.99	0.80	242.13	-37.07	-27.09	0.04	133.20	-12.76	0.23	74.01
21.5	-25.42	0.05	206.39	-2.10	0.79	227.84	-40.39	-28.85	0.04	68.10	-13.12	0.22	68.84
24.0	-24.66	0.06	209.77	-2.10	0.78	209.72	-34.46	-24.31	0.06	6.26	-12.11	0.25	54.32
26.5	-21.90	0.08	223.86	-2.39	0.76	191.82	-31.38	-19.43	0.11	-33.31	-12.03	0.25	38.26

Note:

1. Three-port-wafer-probed data: Port 1 = RF Input, Port 2 = Selected RF Output (i.e., ON throw), and Port 3 = Unselected RF Output (i.e., OFF throw).

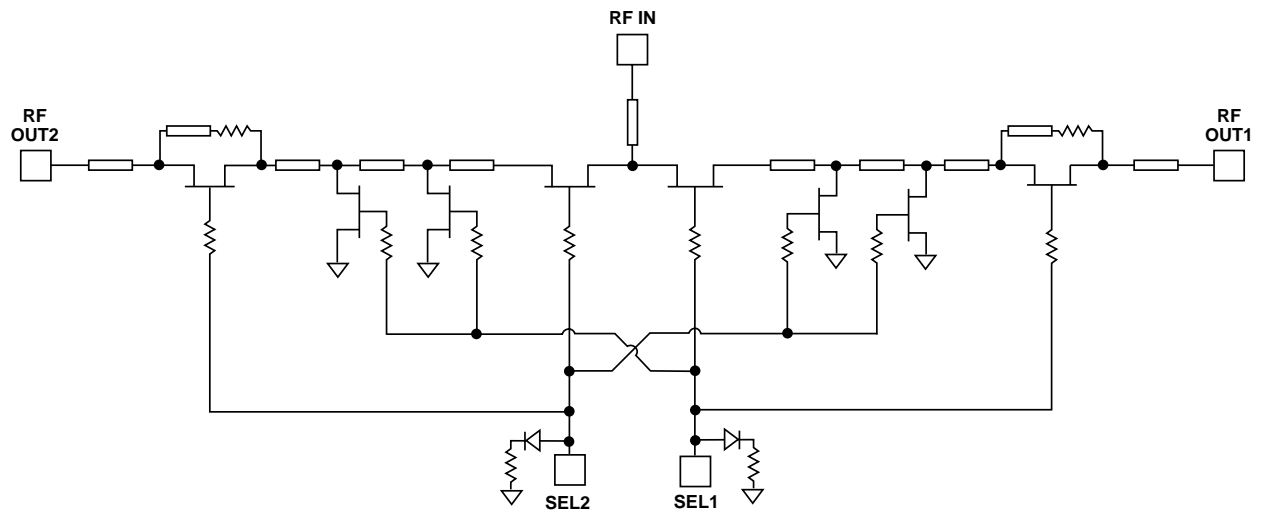

Figure 1. HMMC-2027 Schematic.

Recommended Operating Conditions, $T_A = 25^\circ\text{C}$

Select Line		RF Path	
SEL1	SEL2	RF IN to RF OUT1	RF IN to RF OUT2
-10 V	0 V	Isolated	Low Loss
0 V	-10 V	Low Loss	Isolated

HMMC-2027 Typical Performance

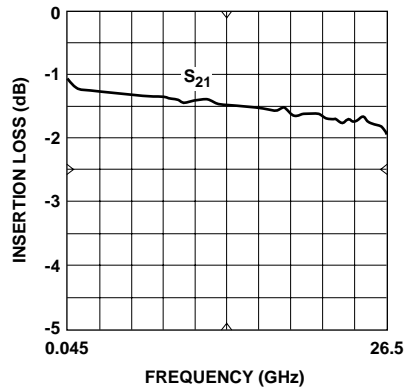

Figure 2. Insertion Loss^[1] vs. Frequency.

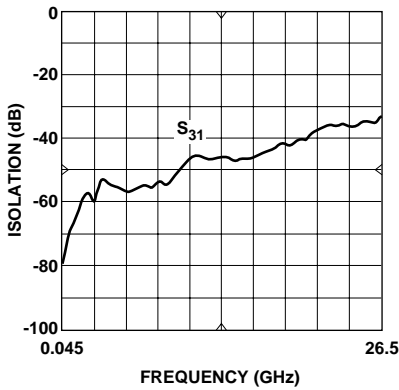

Figure 3. Input-to-Output Isolation^[1] vs. Frequency.

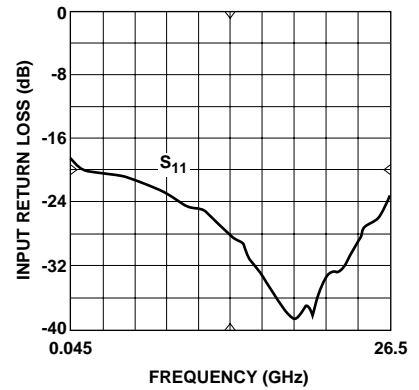

Figure 4. Input Return Loss^[1] vs. Frequency.

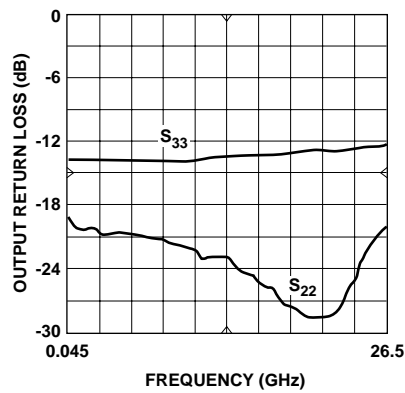

Figure 5. Output Return Loss^[1] vs. Frequency.

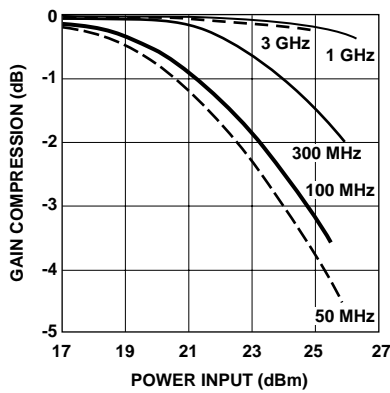

Figure 6. Gain Compression^[2] vs. Power Input.

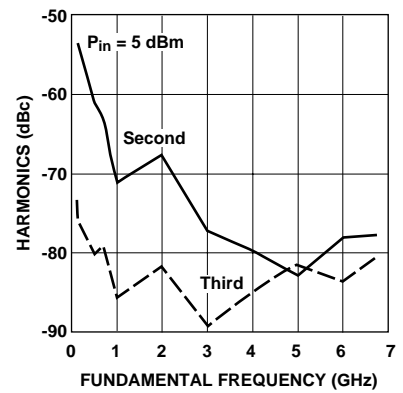

Figure 7. Harmonics vs. Fundamental Frequency^[2,3].

Notes:

1. Data obtained from wafer-probed measurements.
2. All compression and harmonic data measured on individual device mounted in an HP83040 Series Modular Microcircuit Package @ $T_{\text{case}} = 25^{\circ}\text{C}$.
3. Harmonic data points below -80 dBc are at or near the noise floor of the measurement system.

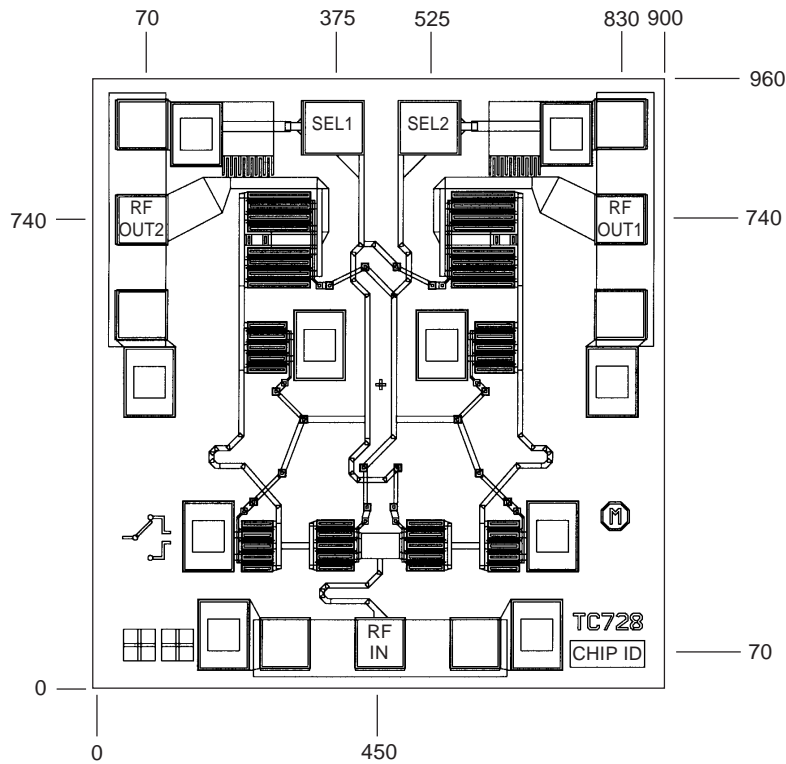

Figure 8. HMMC-2027 Bonding Pad Locations. (Dimensions in micrometers)

Note:

All compression data measured in an individual device mounted in an HP83040 Series Modular Microcircuit Package @ $T_{\text{case}} = 25^{\circ}\text{C}$.

This data sheet contains a variety of typical and guaranteed performance data. The information supplied should not be interpreted as a complete list of circuit specifications. In this data sheet the term *typical* refers to the 50th percentile performance. For additional information contact your local Agilent sales representative.